







To order items on this page — full catalog number requires prefix

Tempersafe™ PRESSURE BALANCE TUB/SHOWER COMBINATIONS

Valve with Service Stops.  ‡ 35.205 Metal trim	Valve with Service Stops.  ‡ 35.200* Acrylic trim	Shower Combination with Service Stops.  ‡ 35.220 Acrylic trim	Shower/Tub Combination with Service Stops.  ‡ 35.221 Acrylic trim	Shower Combination with Service Stops.  ‡ 35.202* Acrylic trim	Shower/Tub Combination with Service Stops.  ‡ 35.207* Acrylic trim
---	--	--	--	---	---

‡ = Also in commercial line

GROHE AMERICA 

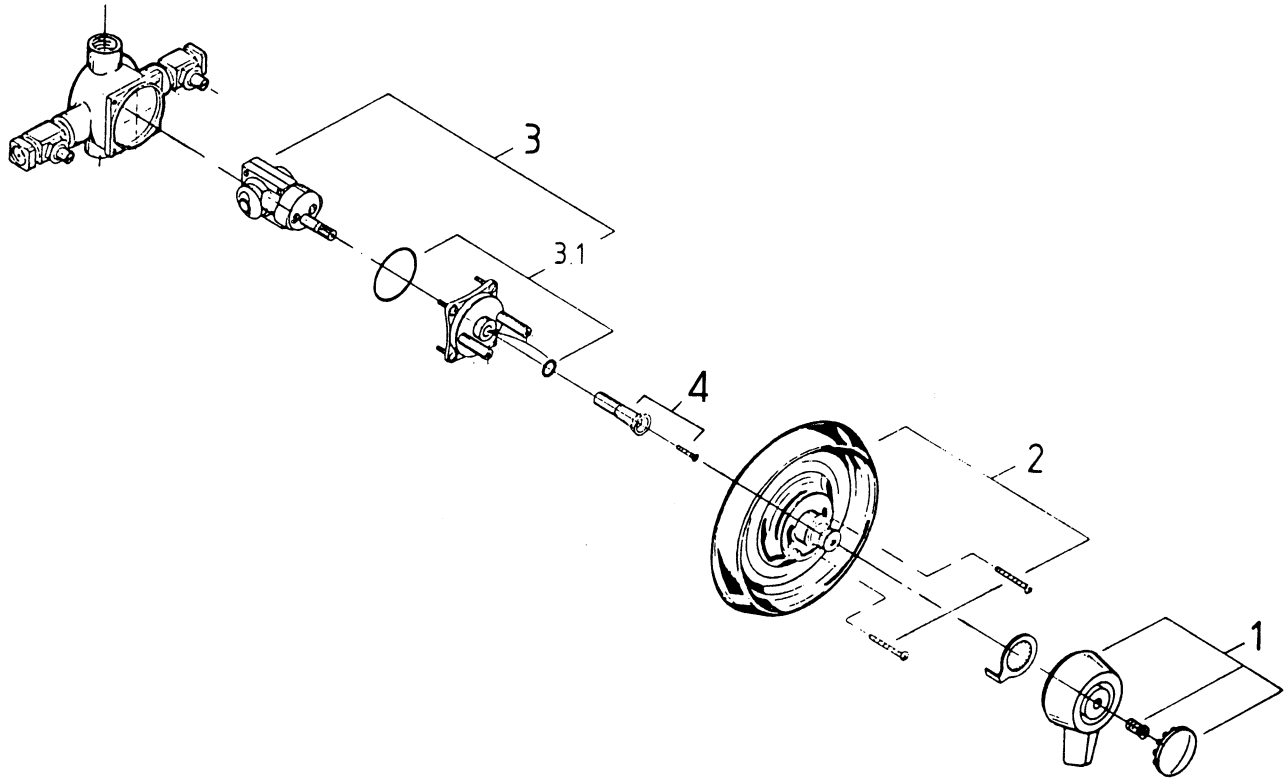

Drg Ref	Description	Cat. No.	Pkg. Unit
1	Metal lever handle Cpl.	47.198	1
1	Acrylic lever handle Cpl.	47.077	1
2	Metal escutcheon and screws	47.211	1
2	Acrylic escutcheon and screws	47.078	1
3	Cartridge	47.080	1
3.1	O-ring set	47.086	1
4	Driver kit	47.068	1